

# Instruction of Heat towel bar

## General installation

DPE5374-7

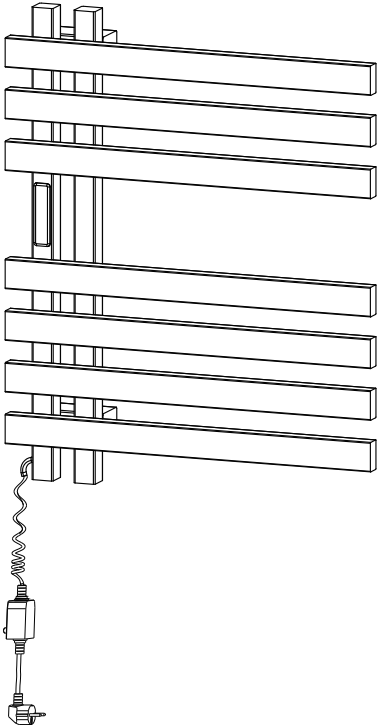

DPE5374-9

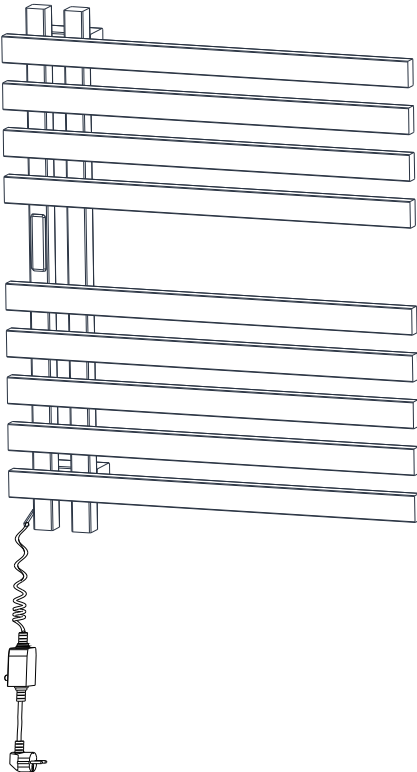

DPE5374-12

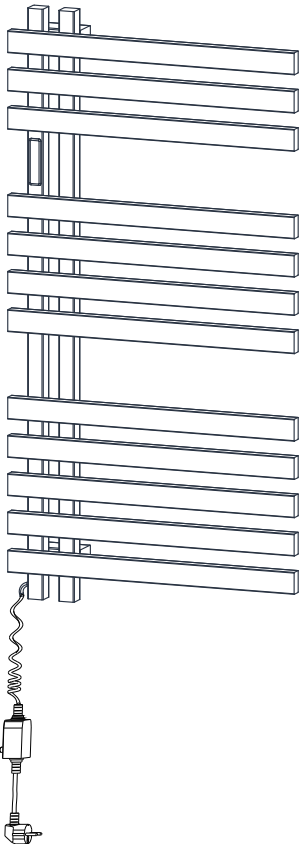

## Installation tool

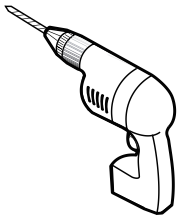

Drill

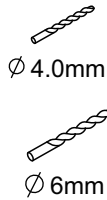

Drill bits

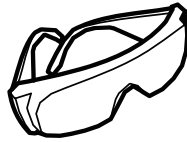

Goggle

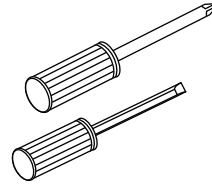

Phillips/Regular Screwdriver

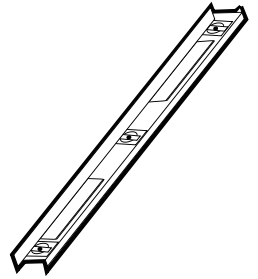

Ruler

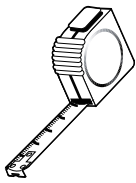

Tape measure



Pen

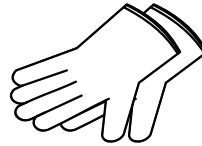

Protective gloves

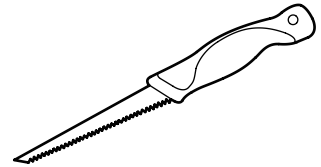

Utility Knife

## Installation precautions

- Please read this guide carefully to familiarize yourself with the tools, materials and installation procedures required. Please follow the applicable section to install the product to avoid improper installation resulting in unnecessary damage. In addition to the correct installation method, please read the operation and safety instructions
- All information contained in this guide is based on the current product condition at the time of printing. The company reserves the right to change product features, packaging or supply conditions at any time without prior notice.
- The guide also contains information on maintenance, cleaning, etc.
- Please read this guide carefully before installing the product
- It must be installed by a qualified electrician
- Make sure the power connection is turned off before installation or maintenance
- The product is for indoor use only



Caution: Possible risk of injury to person or damage of product. To ensure the safety of installation, please equip yourself with protection equipment.



Caution: Do not use acid, alkaline detergent and alcohol to clean the surface. Please use a damp cloth to clean.



It may need to be rewired in case of electric shock



Please attention: The product is a hanging single side rail. Please check whether there are obstacles in the inner space of the wall before installation. (e.g. water and electricity pipes).

## Material list

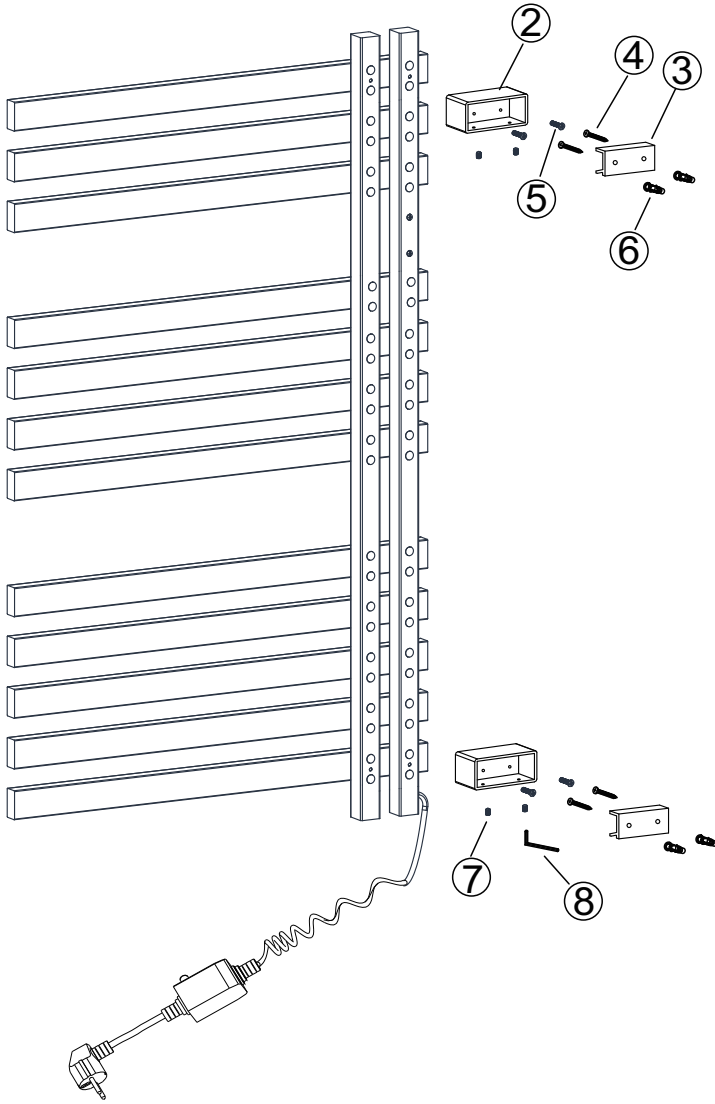

N0.	Item	Quantity
1	Towel rail	1
2	Socket	2
3	Wall base	3
4	Screws	4
5	M4*8	4
6	Wall anchors	4
7	Jackscrews	4
8	Spanner	1

## General installation

### 1. Attach the socket to the back of the towel rail

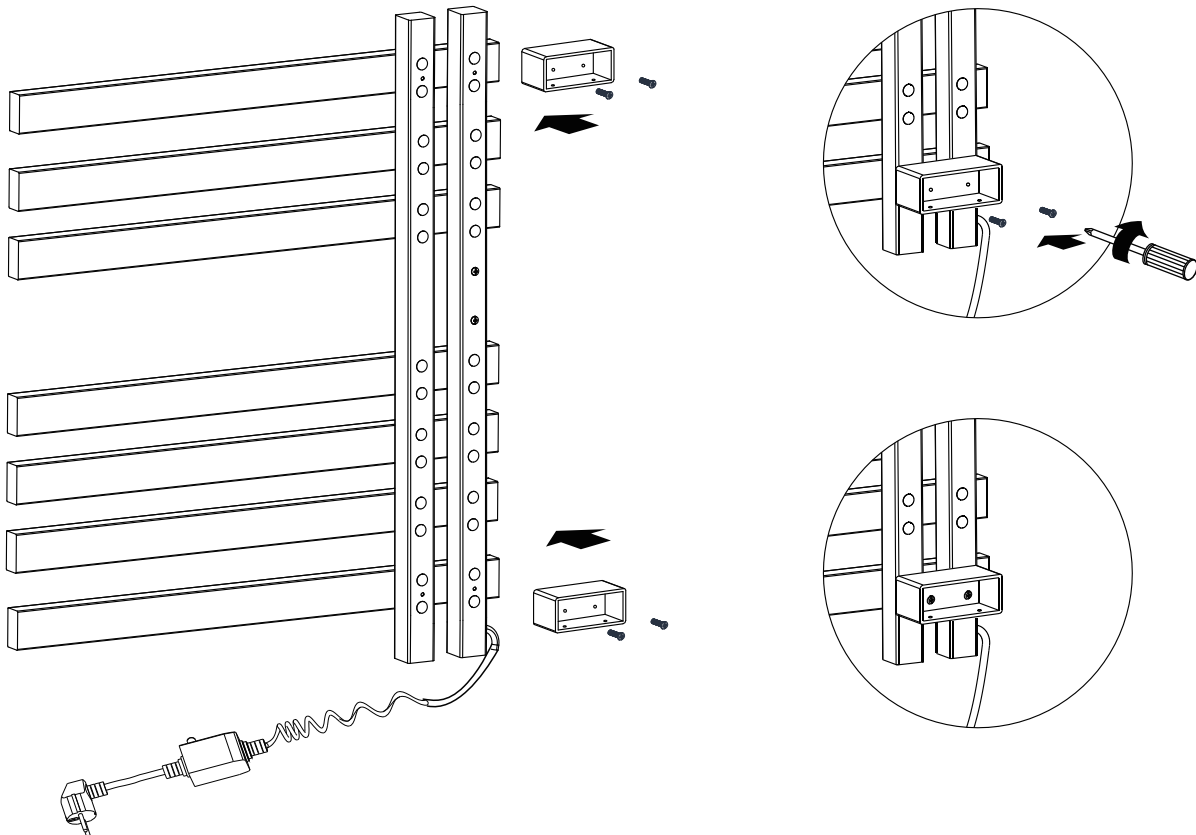

2. Install the wall base on the back of the towel rail according to the drawing, and then put the towel rail on the wall.

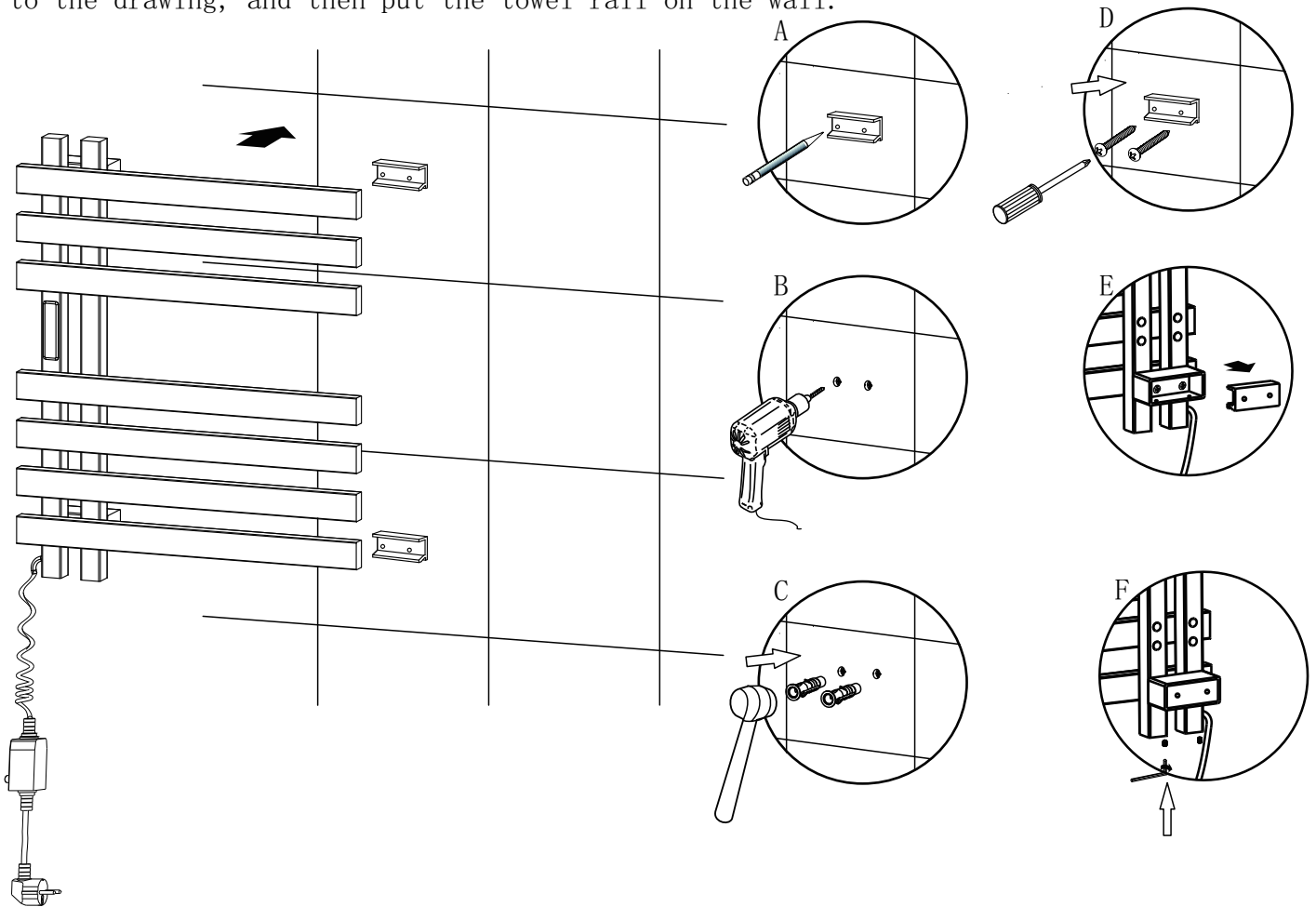

Operation guide for socket and temperature controlled switch

After leakage protection power off, press this button to return to normal

Leakage test key

Leakage reset key

Press test key to test whether to protect the power off. Press this key and then press the reset key to restore normal power supply

<p>Without electricity</p> <p>Temperature / time display</p> <p>Temperature adjustment touch key</p> <p>Power switch and timing adjustment touch key</p> <p>It glows when power on, keep pressing about 5 seconds, the display screen has a digital display (as shown in the right picture) the towel rail starts to work</p>	<p>In the electricity (Timing setting)</p> <p>Click here to set the timing time (there are 1-8 hours optional), the key stops flashing, and the setting is completed</p>	<p>In the electricity (Temperature setting)</p> <p>Click here to set the temperature (there are 45, 50, 55, 60, 65, 70 degrees optional), the key stops flashing, and the setting is completed</p>
---	--	--